

KT1-7 (TO-18)

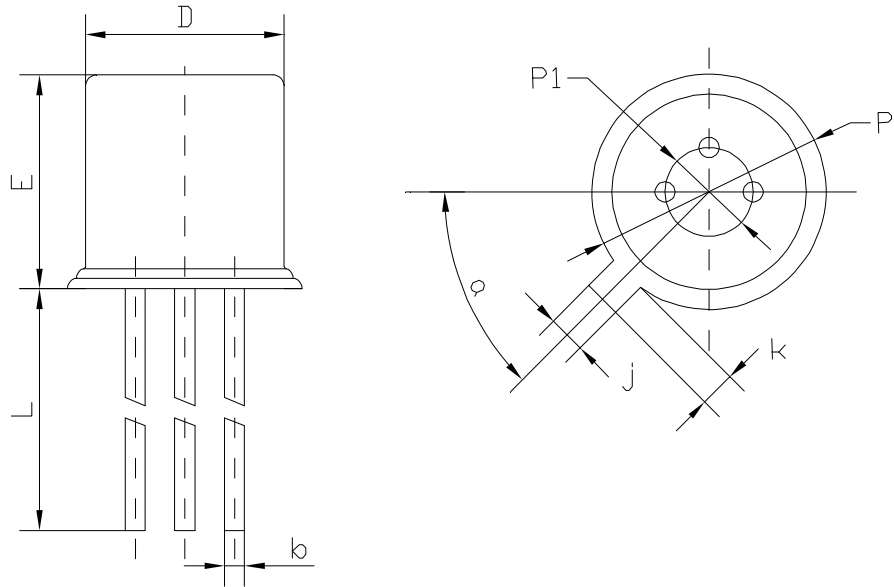

Dimension	mm	
	min	max
b		0.5
D		4.95
E		5.3
L	12.5	14.5
P		5.84
P1	2.2	2.6
j	0.94	1.12
k	0.88	1.12
a	40°	50°